



doga

LEVELLING SYSTEM



doga

LEVELLING SYSTEM

v.4 INDEX

LEVELLING

02 levelling system

08 tile spacers

09 pedestals

12 fixed paving supports

13 facade, security and formwork

FINISHED

15 electrical accesories

18 aluminium profiles

20 hand tools

24 drill bits cutting discs

26 manual ceramic tile cutter

30 manutención de gres porcelánico

32 DOGA drain



levelling system

DOUBLE CLIP

3-12mm

REFERENCE	PRODUCT	PCS PER BAG	BAGS PER BOX	PCS PER BOX	MINIMUM ORDER QUANTITY
DGSTD605-250	Double Clip. 0,5mm	250	14	3500	1 box
DGSTD610-250	Double Clip. 1mm	250	14	3500	1 box
DGSTD615-250	Double Clip. 1,5mm	250	14	3500	1 box
DGSTD620-250	Double Clip. 2mm	250	14	3500	1 box
DGSTD630-250	Double Clip. 3mm	250	14	3500	1 box

It can be used with



DOUBLE CLIP
REGISTERED MODEL



STANDARD CLIP

3-12mm

REFERENCE	PRODUCT	PCS PER BAG	BAGS PER BOX	PCS PER BOX	MINIMUM ORDER QUANTITY
LSSTD610-250	Stand Clip. 1mm	250	14	3500	1 box
LSSTD615-250	Stand Clip. 1,5mm	250	14	3500	1 box
LSSTD620-250	Stand Clip. 2mm	250	14	3500	1 box
LSSTD630-250	Stand Clip. 3mm	250	14	3500	1 box
LSSTD640-250	Stand Clip. 4mm	250	14	3500	1 box
LSSTD650-250	Stand Clip. 5mm	250	14	3500	1 box

It can be used with



STANDARD CLIP
REGISTERED MODEL

Self-leveling clips are used to ensure that ceramic tiles are leveled before being installed. These clips are placed between the tiles and automatically adjusted to level the tile and ensure it is flat and free of irregularities.

They are especially useful in areas with irregular soils or with changes in level. They help ensure the tiles are level and there are no irregularities in the floor, which can prevent aesthetic and functional problems in the future.

HIGH CLIP

12-20mm

REFERENCE	PRODUCT	PCS PER BAG	BAGS PER BOX	PCS PER BOX	MINIMUM ORDER QUANTITY
DGALTA10-200	High clip 1mm	200	12	2400	1 box
DGALTA15-200	High clip 1,5mm	200	12	2400	1 box
DGALTA20-200	High clip 2mm	200	12	2400	1 box
DGALTA30-200	High clip 3mm	200	12	2400	1 box
DGALTA40-200	High clip 4mm	200	12	2400	1 box
DGALTA50-200	High clip 5mm	200	12	2400	1 box

NEW
NEW

It can be used with



HIGH CLIP
REGISTERED MODEL



WEDGE

REFERENCE	PCS PER BAG	BAGS PER BOX	PCS PER BOX	MINIMUM ORDER QUANTITY
DGCUNA01-100	100	20	2000	1 box
DGCUNA01-250	250	8	2000	1 box
DGCUNA02-100	100	20	2000	1 box
DGCUNA02-250	250	8	2000	1 box



- They are millimetric (as the previous ones), helping to a perfect levelling of the tile.
- The rear area is wider and higher, allowing it to be placed with the fingers/palm of the hand.
- Design of the wedge tip with joint size indications, which can help to realise the joint width especially in large formats (placing the wedge vertically).



Cale
DGCUNA01



Wedge
DGCUNA02

TILE LEVELLING PLIERS

REFERENCE	PCS PER BOX	MINIMUM ORDER QUANTITY
PINZA019-N	5	1 box
PINZADOGA	5	1 box



PINZA019-N

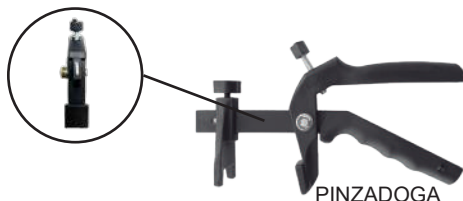

PINZADOGA



Metal pliers reinforced with plastic for greater resistance to use

DOGA LEVELLING SYSTEM KIT

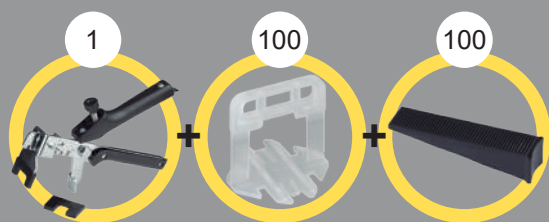

REFERENCE	PRODUCT	DOGA KIT	PCS PER BOX	MINIMUM ORDER QUANTITY
DGKITC005-100	KIT 0,5mm	100 WEDGES + 100 CLIPS + 1 PLIERS	4	1 box
DGKITC010-100	KIT 1mm	100 WEDGES + 100 CLIPS + 1 PLIERS	4	1 box
DGKITC015-100	KIT 1,5mm	100 WEDGES + 100 CLIPS + 1 PLIERS	4	1 box
DGKITC020-100	KIT 2mm	100 WEDGES + 100 CLIPS + 1 PLIERS	4	1 box
DGKITC030-100	KIT 3mm	100 WEDGES + 100 CLIPS + 1 PLIERS	4	1 box
LSKITC010-100	KIT 1mm	100 WEDGES + 100 CLIPS + 1 PLIERS	4	1 box
LSKITC015-100	KIT 1,5mm	100 WEDGES + 100 CLIPS + 1 PLIERS	4	1 box
LSKITC020-100	KIT 2mm	100 WEDGES + 100 CLIPS + 1 PLIERS	4	1 box
LSKITC030-100	KIT 3mm	100 WEDGES + 100 CLIPS + 1 PLIERS	4	1 box
LSKITC040-100	KIT 4mm	100 WEDGES + 100 CLIPS + 1 PLIERS	4	1 box
LSKITC050-100	KIT 5mm	100 WEDGES + 100 CLIPS + 1 PLIERS	4	1 box



3-12mm

STANDARD CLIPS BOX

	REFERENCE	PRODUCT	PCS PER BOX
1 mm	LSPROC10 - 500	Stand Clip. 1mm	500
	LSPROC10-1000	Stand Clip. 1mm	1000
	LSPROC10-2000	Stand Clip. 1mm	2000
	LSPROC10-4000	Stand Clip. 1mm	4000
1,5 mm	LSPROC15 - 500	Stand Clip. 1,5mm	500
	LSPROC15-1000	Stand Clip. 1,5mm	1000
	LSPROC15-2000	Stand Clip. 1,5mm	2000
	LSPROC15-4000	Stand Clip. 1,5mm	4000
2 mm	LSPROC20 - 500	Stand Clip. 2mm	500
	LSPROC20-1000	Stand Clip. 2mm	1000
	LSPROC20-2000	Stand Clip. 2mm	2000
	LSPROC20-4000	Stand Clip. 2mm	4000
3 mm	LSPROC30 - 500	Stand Clip. 3mm	500
	LSPROC30-1000	Stand Clip. 3mm	1000
	LSPROC30-2000	Stand Clip. 3mm	2000
	LSPROC30-4000	Stand Clip. 3mm	4000
4 mm	LSPROC40 - 500	Stand Clip. 4mm	500
	LSPROC40-1000	Stand Clip. 4mm	1000
	LSPROC40-2000	Stand Clip. 4mm	2000
	LSPROC40-4000	Stand Clip. 4mm	4000
5 mm	LSPROC50 - 500	Stand Clip. 5mm	500
	LSPROC50-1000	Stand Clip. 5mm	1000
	LSPROC50-2000	Stand Clip. 5mm	2000
	LSPROC50-4000	Stand Clip. 5mm	4000

3-12mm

DOUBLE CLIPS BOX

	REFERENCE	PRODUCT	PCS PER BOX
0,5 mm	DGPROC05 - 500	Double clip 0,5mm	500
	DGPROC05-1000	Double clip 0,5mm	1000
	DGPROC05-2000	Double clip 0,5mm	2000
	DGPROC05-4000	Double clip 0,5mm	4000
1 mm	DGPROC10 - 500	Double clip 1mm	500
	DGPROC10-1000	Double clip 1mm	1000
	DGPROC10-2000	Double clip 1mm	2000
	DGPROC10-4000	Double clip 1mm	4000
1,5 mm	DGPROC15 - 500	Double clip 1,5mm	500
	DGPROC15-1000	Double clip 1,5mm	1000
	DGPROC15-2000	Double clip 1,5mm	2000
	DGPROC15-4000	Double clip 1,5mm	4000
2 mm	DGPROC20 - 500	Double clip 2mm	500
	DGPROC20-1000	Double clip 2mm	1000
	DGPROC20-2000	Double clip 2mm	2000
	DGPROC20-4000	Double clip 2mm	4000
3 mm	DGPROC30 - 500	Double clip 3mm	500
	DGPROC30-1000	Double clip 3mm	1000
	DGPROC30-2000	Double clip 3mm	2000
	DGPROC30-4000	Double clip 3mm	4000





CLIP COMPATIBLE WITH A THREAD NEW 3-14mm

REFERENCE	PRODUCT	PCS PER BAG	BAGS PER BOX	PCS PER BOX	MINIMUM ORDER QUANTITY
DGROSC05-250	Threaded clip 0,5mm	250	12	3000	1 box
DGROSC10-250	Threaded clip 1mm	250	12	3000	1 box
DGROSC15-250	Threaded clip 1,5mm	250	12	3000	1 box
DGROSC20-250	Threaded clip 2mm	250	12	3000	1 box
DGROSC30-250	Threaded clip 3mm	250	12	3000	1 box



CLIP COMPATIBLE WITH A THREAD REGISTERED MODEL

It can be used with  DGCUNA01

It can be used with  DGROSCAV

In DOGA we like to adapt to our customers, that's why we launched the new clip compatible with thread. This can be used with both the wedge and the thread.

PRINCIPAL ADVANTAGES:

- Clip compatible with fabricado thread with **recycled material**
- Clip compatible with **thread and wedge**
- Easy to use
- Saving costs and time
- **Reusable** thread
- Perfect and clean break
- Fine-tuning



THREAD NEW

REFERENCE	PRODUCT	PCS PER BAG	BAGS PER BOX	PCS PER BOX	MINIMUM ORDER QUANTITY
DGROSCAV-50	Rosca Verde	50	24	1200	1 box
DGROSCAV-100	Rosca Verde	100	12	1200	1 box



THREAD REGISTERED MODEL

Thread for levelling:
Easy and easy to use, designed to save costs and time. In addition, it is reusable, after having used it you will only have to put it back up to siquiente placement. Perfect and clean break. With the thread system you will be able to adjust more precisely.



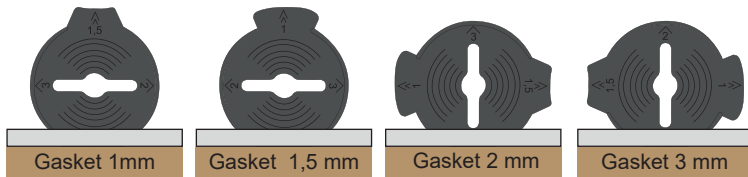

PROTECTOR + DOGA ROLL SEPARATOR

REFERENCE	PCS PER BAG
PROTEROLL-100	100

We want to protect your coating and polish, that when breaking the clip does not go the polish or scratch the polish. This protector can be used for both the Roll range and the Doga range of clips and wedges. It is perfectly suited to both levelling systems.



DOGA ROLL PROTECTOR

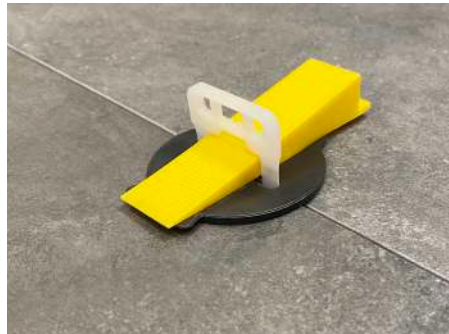

KIT BAG DOGA ROLL

REFERENCE	PRODUCT	KIT BAG	BAGS PER BOX	MINIMUM ORDER QUANTITY
NEW ROLLKIT10-150	KIT 1mm	150 DOGA ROLL CLIPS + 50 DOGA ROLL	12	1 box
ROLLKIT15-150	KIT 1,5mm	150 DOGA ROLL CLIPS + 50 DOGA ROLL	12	1 box
ROLLKIT20-150	KIT 2mm	150 DOGA ROLL CLIPS + 50 DOGA ROLL	12	1 box
ROLLKIT30-150	KIT 3mm	150 DOGA ROLL CLIPS + 50 DOGA ROLL	12	1 box



DOGA ROLL

DOGA ROLL

REFERENCE	PRODUCT	PCS PER BAG	BAGS PER BOX	PCS PER BOX	MINIMUM ORDER QUANTITY
DGROSCA-100	DOGA Roll thread	100	15	1500	1 box



DOGA ROLL CLIP

DOGA ROLL CLIP

REFERENCE	PRODUCT	PCS PER BAG	BAGS PER BOX	PCS PER BOX	MINIMUM ORDER QUANTITY
NEW DGROLL10-100	DOGA Roll clip 1mm	200	20	4000	1 box
DGROLL15-100	DOGA Roll clip 1,5mm	200	20	4000	1 box
DGROLL20-100	DOGA Roll clip 2mm	200	20	4000	1 box
DGROLL30-100	DOGA Roll clip 3mm	200	20	4000	1 box

1. After spreading the adhesive, insert a doga roll clip under the tile at each intersection. Depending on the dimensions of the tile, place one or several clips per side.

2. Place the doga roll into the edge of the doga roll clip and screw in until the tiles are correctly aligned.

3. As soon as the adhesive has dried, snap off the upper part of the clip with a rubber mallet or simply kick off the side of it.

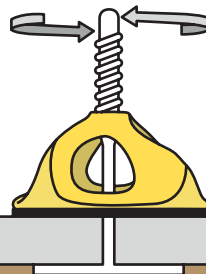



Flooring and tiling the professional way

An ingenious and revolutionary system. DOGA LEVELLING KIT is a useful system for all kinds of flooring and tiling.

PERFECT FOR ANY KIND OF SURFACE

- Floors
- Walls
- Ceramic tiles

ADVANTAGES

- Quick and easy to use.
- Time-saving
- Guaranteed even tile surface whatever size the tiles are.
- Neat and tidy finish
- Reusable

Table for the calculation of necessary pieces per m²

A cm	10	15	20	25	30	35	40	45	50	55	60	65	70	80	90	100	110	120	140	150	180	200	
10	200																						
15	133	89																					
20	100	67	50																				
25	80	53	40	32																			
30	100	44	40	33	33																		
35	100	67	50	40	29	28																	
40	100	67	50	40	33	29	25																
45	89	59	44	36	30	25	22	20															
50	80	53	40	32	27	23	20	18	16														
55	73	48	36	29	24	21	18	16	15	13													
60	75	50	37	30	25	21	19	17	15	14	13												
65	69	46	35	28	23	20	17	15	14	13	12	11											
70	71	48	36	29	24	20	18	16	14	13	12	11	10										
80	69	46	34	28	23	20	17	15	14	12	11	10	9										
90	61	41	31	24	20	17	15	14	12	11	10	9	8	7									
100	60	40	30	24	20	17	15	13	12	11	10	9	8	7	6								
110	59	39	30	24	20	17	15	13	12	11	10	9	8	7	6	5							
120	54	36	27	22	18	15	14	12	11	10	9	8	7	6	6	5	5						
140	45	28	20	17	17	13	12	12	11	10	9	8	7	6	6	5	4	4					
150	45	26	21	17	17	13	12	12	11	9	9	8	8	7	6	6	5	4	3	3			
180	45	30	21	17	17	13	12	12	11	9	9	8	8	7	6	6	5	4	3	3	3		
200	40	28	20	16	16	12	12	12	10	9	8	8	7	7	6	5	4	4	3	3	3	3	
	10	15	20	25	30	35	40	45	50	55	60	65	70	80	90	100	110	120	140	150	180	200	B cm

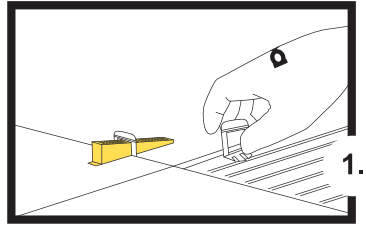
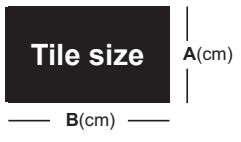

After spreading the adhesive, insert a clip under the tile at each intersection, depending on the dimensions of the tile, place one or several clips per side.

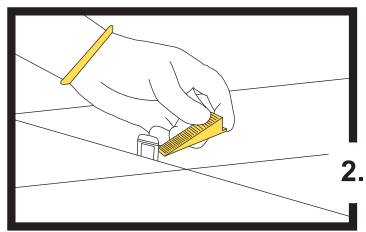

Place the wedge in the gap of the clip.

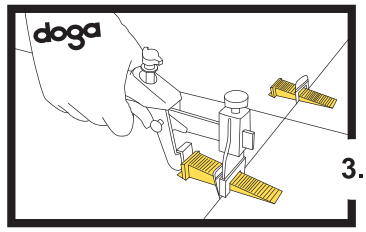

Use the adjustable pliers for perfect levelling, being careful not to move the breaking point.

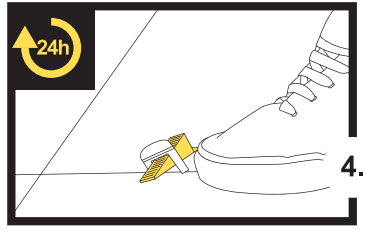

As soon as the adhesive has dried, snap off the upper part of the clip with a rubber mallet or simply kick off the side of it.





tile spacers

BASIC TILE SPACERS



REFERENCE	PRODUCT	UNITS BAG	BAGS / BOX	UNITS / BOX	MINIMUM ORDER QUANTITY
CRX00B10	Tile spacer 1mm	500	60	30.000	1 bag
CRX00B15	Tile spacer 1,5mm	500	60	30.000	1 bag
CRGROVED2	Tile spacer 2mm	500	60	30.000	1 bag
CRGROVED3	Tile spacer 3mm	300	60	18.000	1 bag
CRGROVED4	Tile spacer 4mm	300	60	18.000	1 bag
CRGROVED5	Tile spacer 5mm	150	60	9.000	1 bag
CRGROVED7	Tile spacer 7mm	100	60	6.000	1 bag
CRGROVED10	Tile spacer 10mm	40	50	2.000	1 bag
CRGROVED15	Tile spacer 15mm	30	50	1.500	1 bag
DG203543	Tile wedge	300	100	30.000	1 bag

NEW
NEW
NEW
NEW

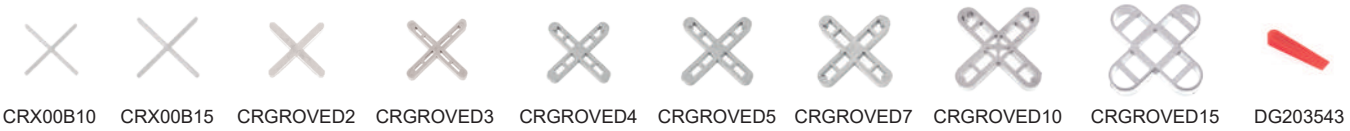

The crosspieces are used as a complementary component to the levelling wedges and clips. These will be responsible for levelling our flooring or cladding and the crosshead will maintain a constant separation between all ceramic parts.

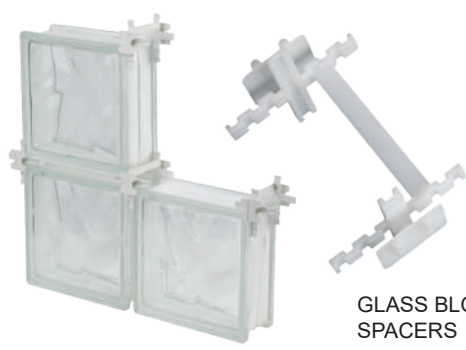

GLASS BLOCK SPACERS

GLASS BLOCK SPACERS

REFERENCE	PRODUCT	UNITS / BOX
DG206308	Glass block spacers 10mm	120
DG206315	Glass block spacers 10mm	300
DG206322	Glass block spacers 10mm	600

For standard blocks 19 x 19 x 8 mm

DOGA PEDESTALS: adjustable supports for high floors

PEDESTAL CALCULATION

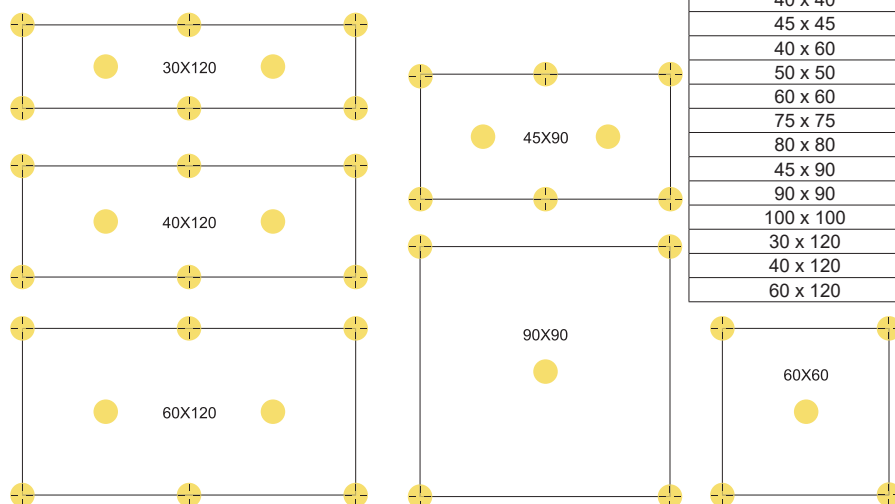

TILE MEASUREMENTS cm	N° PEDESTALS / m ²	WITH CENTRAL PEDESTALS
30 x 30	12,5 units	
30 x 60	6,5 units	
40 x 40	6,9 units	
45 x 45	6,9 units	
40 x 60	4 units	
50 x 50	4,5 units	
60 x 60	3,4 units	6,3 units
75 x 75	2,3 units	4,3 units
80 x 80	2 units	3,7 units
45 x 90		5,8 units
90 x 90	1,7 units	3,1 units
100 x 100		4,5 units
30 x 120		6,4 units
40 x 120		4,8 units
60 x 120		3,4 units

EXAMPLE CALCULATION:

AREA: 50 m²

TILE: 60 X 60 cm = 3,4 units.

PEDESTAL: 50 m² X 3,4 units = 170 units

FIXED PEDESTALS NEW

REFERENCE	SIZES	UNITS BOX	PACK PALLET
DGE204731	14 mm	260	27
DGE204748	16 mm	150	27
DGE204755	20 mm	180	27
DGE204762	30mm	120	27



DGE204731



DGE204748



DGE204755



DGE204762

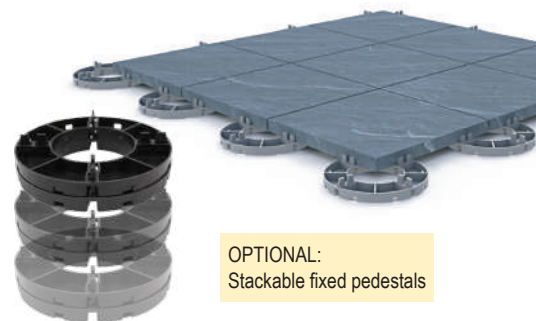

OPTIONAL:
Stackable fixed pedestals

The fixed pedestals consists of a high resistance base which is placed directly onto the waterproofing layer. The paving slabs are then placed directly onto the supports without the use of concrete or adhesives of any kind. The base of the support is made of HDPE material and its shape allows rainwater to drain and flow easily on the underlying waterproof layer, avoiding water stagnation.

ADVANTAGES:

- Low installation cost
- Fast accessibility by moving any paving slab of the practicable surface in need of inspection of the inner layer, which can even be done without breaking any paving slab
- Roof insulation thanks to the cavity formed between the inner layer and the practicable surface

ADJUSTABLE PEDESTALS NEW

REFERENCE	SIZES	UNITS BOX	PACK PALLET
DGE204540	18-25 mm	132	25
DGE204557	28-40 mm	90	25
DGE204564	36-51 mm	60	25
DGE204571	52-82 mm	48	25
DGE204588	83-134 mm	24	25
DGE204595	133-225 mm	24	25



The adjustable pedestals are made of the highest quality polypropylene and with suitable additives to guarantee long life and increased load capacity.

They can be used with a wide range of different types of paving, such as tiles, marble, stone, wood, etc. It is the perfect solution for turning non-practicable areas into practicable ones, whether they are waterproofed or not, also allowing the laying of cables and pipes that are normally present in offices, shops, and work environments.

For this reason, raised floors are mainly used in new buildings but also in refurbishing projects where maximum design and flexibility are required; or simply to ease inspection of the waterproofing layer, pipes, cables, etc.

To all these **adjustable pedestals can be added a self-leveling head of 7%**, thus becoming an adjustable self-leveling plot.

In addition, there are infinite combinations with all the accessories, thus being optimal for all types of facilities.

REFERENCE	SIZES	ADAPTERS NUMBER	UNITS BOX	ASSEMBLY
DGE204816	189-293 mm	1 - DGE204601	24	DGE204588 x 1 DGE204601
DGE204823	260-365 mm	1 - DGE204601	24	DGE204595 x 1 DGE204601
DGE204830	364-507 mm	2 - DGE204601	24	DGE204595 x 2 DGE204601
DGE204847	471-651 mm	3 - DGE204601	24	DGE204595 x 3 DGE204601
DGE204854	576-795 mm	4 - DGE204601	24	DGE204595 x 4 DGE204601
DGE204861	682-939 mm	5 - DGE204601	24	DGE204595 x 5 DGE204601
DGE204878	786-1083 mm	6 - DGE204601	24	DGE204595 x 6 DGE204601

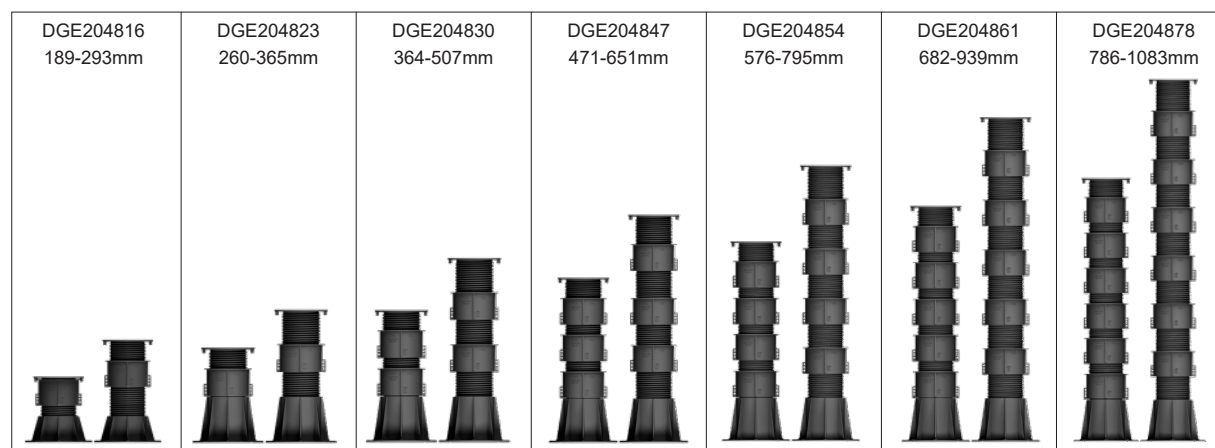



Self-levelling head 7% unevenness **NEW**

REFERENCE	SIZES	UNITS BOX	PACK PALLET
DGE204694	3 mm	24	128
DGE204687	Plano	28	128
DGE204717	Beams up to 40-50mm	20	128
DGE204700	Beams up to 80mm	20	128



GENERAL ACCESORIES **NEW**

REFERENCE	SIZES	UNITS BOX	PACK PALLET
DGE204632	-	40 units/bag - 8 bags	128
DGE204601	-	24	25
DGE204625	-	100	128
DGE204618	2% unevenness	100	128



DGE204632
Shock absorber



DGE204601
Height adapter
(180mm)



DGE204625
Back thread
(10mm)



DGE204618
Leveling disc



FIXED ACCESORIES **NEW**

REFERENCE	SIZES	UNITS BOX	PACK PALLET
DGE204649	3 mm	40 units/bag - 13 bags	128
DGE204656	3 mm	40 units/bag - 25 bags	128
DGE204670	-	40 units/bag - 11 bags	128
DGE204663	40-50 mm	32	128



DGE204649
Central separator
crosshead (16mm)



DGE204656
Straight separator



DGE204670
Tracking adapter



DGE204663
Tracking adapter



OTHER ACCESORIES **NEW**

REFERENCE	UNITS BOX
DGE204779	100 units/bag - 5 bags
DGE204724	100
DGE204793	100
DGE204809	100
DGE204786	4 units/bag
DGE206148	2 units/bag



DGE204786



DGE204779

Height adjustable key: With this key we can adjust the height of the self-levelling head. It can be used during final assembly or when laying tiles.

Central fixing screw: Wind protector that prevents the pavement from lifting in strong winds.



DGE204724

Wall separator: Can be used with all our pedestals. It creates a gap between the pedestal and the wall allowing a perfect water flow, even in adverse weather conditions (heavy rain, snow, etc.).



DGE206148

Adapter tool for drill: With this key we can adjust the height of the self-levelling head. It can be used during final assembly or when laying tiles.



DGE204809
Metal clip on the bottom



DGE204793
Metal clip on the top

Metal fitting with vertical end edge clamp



fixed paving supports

DG203550



33.15x33.15cm PLASTIC FLOORING BASE **NEW**

REFERENCE	PRODUCT	UNITS/ BAG	UNITS/ BOX	MEASURES PIECE	M ² / BOX	MINIMUM ORDER QUANTITY
DG203550	Plastic flooring base	-	12	33.15x33.15cm	1.33m ²	1 box
DG204076	Side corner	8	48	33.15cm	-	1 box
DG204083	Corner	4	24	-	-	1 box

SUPPLEMENTS

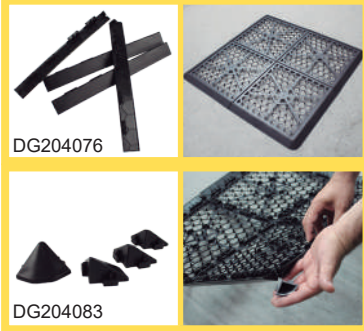

DG204076

DG204083

- Easy assembly and disassembly
- Ideal for outdoors
- The product must be placed on flat and resistant surfaces such as cement, stone or wood

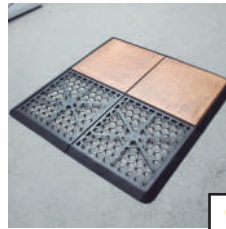

1



2

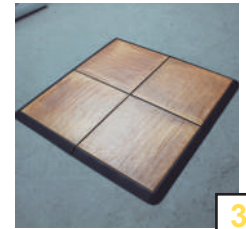

3





facade, security and formwork

SAFETY BRACKET NEW

REFERENCE	PRODUCT	SIZES	MAXIMUM FIXING THICKNESS	UNITS / BOX	MINIMUM ORDER QUANTITY
DGE203772	Safety initial bracket	12mm	view 10mm hidden 20mm	200	1 box
DGE203789	Safety initial bracket	18mm	view 16mm hidden 32mm	200	1 box
DGE203796	Safety intermediate bracket	12mm	view 10mm hidden 20mm	200	1 box
DGE203802	Safety intermediate bracket	18mm	view 16mm hidden 32 mm	200	1 box

Stainless steel AISI-304

Every boxes contain: 200 block 5x25mm + 200 screw 3.5x40mm

The flattened ones placed with glue must also be fixed mechanically to avoid the eventual detachment of tiles. Our staples are pieces of protection and security for tiles in flattened facades. The central safety ones support one tile up and one tile down; the final safety boot tiles are designed for a single tile. If the staple is visible, the maximum thickness of the tile can be 10mm or 16mm; if the tile is grooved its thickness can reach up to 20mm or 32mm.

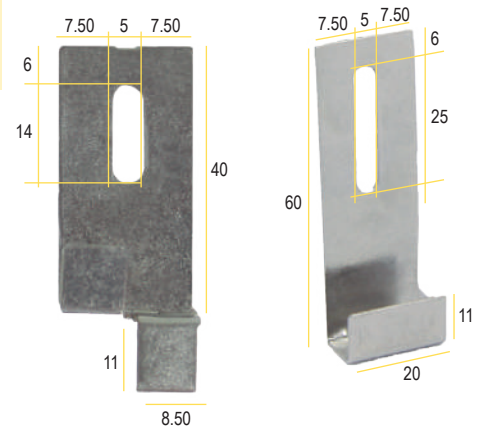

SAFETY CAP NEW

REFERENCE	PRODUCT	UNITS / BAG	MINIMUM ORDER QUANTITY
DG203826	Safety cap (rod from 8 to 20mm)	250	1 bag
DG203833	Safety cap (rod from 24 to 40mm)	150	1 bag



Safety cap in the form of a mushroom. Placement in protruding corrugated steel rod. With its placement protects the worker from sharp rods, in case of fall or friction. The inside of the piece is formed by 4 flexible fins, for the perfect anchoring of the rod.



BASE LIFE LINE NEW

REFERENCE	PRODUCT	SIZES	UNITS / BOX	MINIMUM ORDER QUANTITY
DGE206636	Base life line	60 x 40 mm	50	1 bag

It is used for positioning, fixing and positioning of lifeline poles and network arm poles.

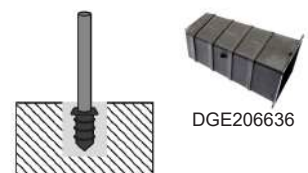

BASE HORCA NEW

REFERENCE	PRODUCT	SIZES	UNITS BAG	MINIMUM ORDER QUANTITY
DG206339	Base horca (safety fence)	80 x 85 mm	64	1 bag

For positioning, fixing and positioning of Horca davits for security fences and their nets in buildings.



DG206339

CONIX BASE NEW

REFERENCE	PRODUCT	SIZES	UNITS BAG	MINIMUM ORDER QUANTITY
DG206346	Conix base	40 mm	150	1 bag

For the placement of body guards in buildings. Avoids work accidents, possible falls of personnel.



DG206346

SAW PLASTIC SPACER NEW

REFERENCE	PRODUCT	SIZES	UNITS TIED	TIED PER PALLET	MINIMUM ORDER QUANTITY
DGE203840	Spacer 25 mm	25mm x 2mts	50 strips (100 mts)	49 tied	1 box
DGE203857	Spacer 30 mm	30mm x 2mts	50 strips (100 mts)	42 tied	1 box
DGE203864	Spacer 40 mm	40mm x 2mts	30 strips (60 mts)	76 tied	1 box
DGE203871	Spacer 50 mm	50mm x 2mts	30 strips (60 mts)	28 tied	1 box

Designed to place corrugated rods at the required distance in the formwork, depending on the concrete load of the structure. They are used for horizontal and vertical surfaces.

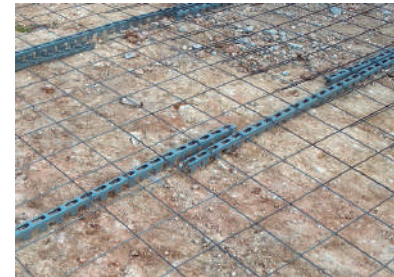

CONDOR SPACER NEW

REFERENCE	PRODUCT	SIZES	UNITS BAG	MINIMUM ORDER QUANTITY
DG203949	Spacer 20 mm	20 mm	1.000	1 bag
DG203956	Spacer 30 mm	30 mm	500	1 bag
DG203963	Spacer 40 mm	40 mm	500	1 bag
DG203970	Spacer 50 mm	50 mm	500	1 bag

Plastic separator for reinforcement in formwork, slabs, prefabricated and building. It is used to maintain the required distance between the steel in the concrete slab, retaining the coatings specified for each structural element. They do not allow corrosion of the armor. Mainly designed for horizontal reinforcements, high strength, for electrowelded mesh or corrugated rod. For all corrugated stockings up to 25 Ø

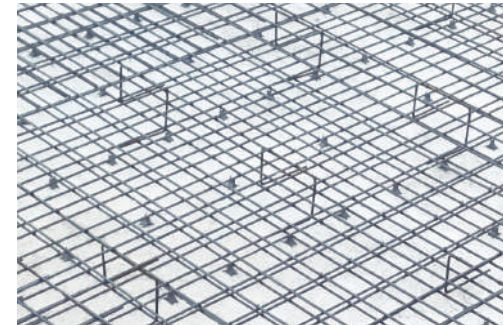

RUDDER SPACER NEW

REFERENCE	PRODUCT	SIZES	Ø DIPSTICK	UNITS BAG	MINIMUM ORDER QUANTITY
DG203987	Spacer 20 mm	20 mm	6 - 12	1.000	1 bag
DG203994	Spacer 25 mm	25 mm	6 - 12	1.000	1 bag
DG204007	Spacer 30 mm	30 mm	6 - 14	500	1 bag
DG204014	Spacer 35 mm	35 mm	6 - 14	500	1 bag
DG204021	Spacer 40 mm	40 mm	12 - 20	200	1 bag
DG204038	Spacer 50 mm	50 mm	12 - 20	200	1 bag
DG204045	Spacer 50 mm	50 mm	12 - 20	200	1 bag
DG204052	Spacer 60 mm	60 mm	12 - 20	200	1 bag
DG204069	Spacer 70 mm	70 mm	12 - 20	150	1 bag

Plastic separator for reinforcement in formwork, pillars, prefabricated and building. It is used to maintain the distance between the steel and the formwork wall, retaining the coatings specified for each structural element. They do not allow corrosion of the armor.

Designed primarily for vertical reinforcements, it has staple action and provides minimal contact with the formwork. It integrates perfectly with concrete.



DG203987



DG203994



DG204007



DG204014



DG204021



DG204038



DG204045
REINFORCED



DG204052



DG204069
REINFORCED





electrical accessories

CABLE REELS NEW

REFERENCE	PRODUCT	MAX POWER	CABLE	SPOOL DIAMETER	MINIMUM ORDER QUANTITY
DG203567	3 (2P+T) with thermostat and cover	250V - 4.000W	H05VV-F 3G 2.5mm ² 25m	255 mm	1 unit
DG203574	3 (2P+T) with thermostat and cover	250V - 4.000W	H05VV-F 3G 2.5mm ² 50m	310 mm	1 unit
DG203581	3 (2P+T) with thermostat and cover	250V - 4.000W	H05VV-F 3G 2.5mm ² 25m	255 mm	1 unit
DG203598	3 (2P+T) with thermostat and cover	250V - 4.000W	H05VV-F 3G 2.5mm ² 50m	310 mm	1 unit
DG203604	3 (2P+T) with thermostat and cover	250V - 4.000W	H05VV-F 3G 2.5mm ² 25m	255 mm	1 unit
DG203611	3 (2P+T) with thermostat and cover	250V - 4.000W	H05VV-F 3G 2.5mm ² 50m	310 mm	1 unit



DG203567



DG203574



DG203581



DG203598



DG203604
IP54



DG203611
IP54



Cable reel with french connection

Cod. DG203581 y DG203598 Spanish connection: Spanish connection: Netherlands, Luxembourg, Austria, Croacia, Suiza, Portugal, Lituania, Grecia, Chipre, Albania, Andorra, Rusia, Bielorusia, Bosnia, Bulgaria, Republica Checa, Estonia, Islas Feroe, Finlandia, Alemania, Hungria, Iceland, Lituania, Letonia, Macedonia, Maconaco, Noruega, Rumania, Eslovenia, Ucrania, Serbia, Montenegro. French connection: Belgium, Slovakia and Tunisia.

CABLE REELS NEW

REFERENCE	PRODUCT	MAX POWER	CABLE	SPOOL DIAMETER	MINIMUM ORDER QUANTITY
DG203628	3 (2P+T) with thermostat and cover	250V - 3.500W	H07RN-F 3G 1.5mm ² 25m	255 mm	1 unit
DG203635	3 (2P+T) with thermostat and cover	250V - 3.500W	H07RN-F 3G 1.5mm ² 50m	310 mm	1 unit
DG203642	3 (2P+T) with thermostat and cover	250V - 4.000W	H07RN-F 3G 2.5mm ² 25m	255 mm	1 unit

- Metal spool and metal frame
- Cable rubber neoprene outdoor

For electrical instalers: Comply with Complementary Technical Instruction n°33 of the Spanish Low Voltage Electrical. Installation Regulations.



DG203628



DG203635



DG203642



LED WORKLIGHT NEW

LED

WATERPROOF
IP65
PROTECTION

LUZ BLANCA · WHITE LIGHT
6500°K
LUMIÈRE BLANCHE · WHITE LIGHT

REFERENCE	PRODUCT	SIZES	FULL POWER	VOLTAGE	MINIMUM ORDER QUANTITY
DGE204205	Led worklight 30W	145x27x130mm	30W	220-240V	1 unit
DGE204212	Led worklight 50W	180x28x165mm	50W	220-240V	1 unit
DGE204229	Led worklight 100W	239x34x214mm	100W	220-240V	1 unit



DGE204205
30W - 2400Lm



DGE204212
50W - 4000Lm



DGE204229
100W - 8000Lm

LED WORKLIGHT NEW WITH SUPPORT

REFERENCE	PRODUCT	SIZES	FULL POWER	VOLTAGE	MINIMUM ORDER QUANTITY	
DGE204236	Led worklight 20W	179x123x240mm	20W	220-240V	1 unit	Rechargeable
DGE204250	Led worklight 30W	228x183x123mm	30W	220-240V	1 unit	
DGE204274	Led worklight 50W	262x228x123mm	50W	220-240V	1 unit	



DGE204236
20W - 1400Lm

LED

LUZ BLANCA · WHITE LIGHT
6500°K
LUMIÈRE BLANCHE · WHITE LIGHT

WATERPROOF
IP65
PROTECTION



DGE204250
30W - 2400Lm



DGE204274
50W - 4000Lm





LED WORKLIGHT NEW WITH TRIPOD

REFERENCE	PRODUCT	SIZES	FULL POWER	VOLTAGE	MINIMUM ORDER QUANTITY
DGE204243	Triple led worklight	550X550X1460 mm	20W	-	1 unit
DGE204267	Led worklight 50W	780x780x1675 mm	50W	220-240V	1 unit
DGE204281	Led worklight 2x50W	780x780x1695 mm	2x50W	220-240V	1 unit

4 h

4,5h - 2,5h - 1,5h
700lm - 1200lm - 2000lm

Micro USB

On / Off

USB

4000K - 6500K

LED

120°
ÁNGULO DE HAZ - BEAM ANGLE
ANGLE DE FASCEAU

WATERPROOF
IP54
PROTECTION

LED

WATERPROOF
IP65
PROTECTION

LANCER - LUZ BLANCA - WHITE LIGHT
6500K
LUMÈRE - LUZ BLANCA - WHITE LIGHT

DGE204243
max 2000Lm

DGE204267
4000Lm

DGE204281
2x4000Lm

LED LAMP NEW

REFERENCE	PRODUCT	FULL POWER	MINIMUM ORDER QUANTITY
DGE203659	Multifunctional headlamp	150 LM	1 unit
DGE203673	Led multifunction work x5	180 LM	1 unit
DGE202553	3 in 1 RECHARGEABLE COB WORK LIGHT	200+60 LM	1 unit

DGE202553

- 3W COB lamp 200lm
- 1W LED flashlight 60lm
- Warning light: red LEDs

DG203673

180° rotation

Head light

Retractable base / clamp

Magnet on the top

USB charge Power indicator

Hook and magnet on the bottom

DG203659

Impact resistant
1M

Runtime
4h HIGH-12h LOW

Effective range
20M

USB charge

Brightness
150LUMENS

Water resistant
IPX4

aluminium profiles

PROFILE L

ANODIZED ALUMINIUM

matt

REFERENCE	HIGH	LONG	UNITS BOX	MINIMUM ORDER QUANTITY
DOGA2726M	8	270	50	1 box
DOGA2727M	10	270	50	1 box
DOGA2728M	12	270	50	1 box



shine

REFERENCE	HIGH	LONG	UNITS BOX	MINIMUM ORDER QUANTITY
DOGA2726B	8	270	50	1 box
DOGA2727B	10	270	50	1 box
DOGA2728B	12	270	50	1 box

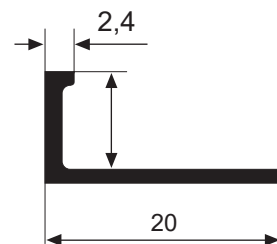

black

REFERENCE	HIGH	LONG	UNITS BOX	MINIMUM ORDER QUANTITY
DOGA2726N	8	270	50	1 box
DOGA2727N	10	270	50	1 box
DOGA2728N	12	270	50	1 box



CURVED STEP

ANODIZED ALUMINIUM

matt

REFERENCE	HIGH	LONG	UNITS BOX	MINIMUM ORDER QUANTITY
DOGA2795M	11	270	50	1 box
DOGA2700M	13	270	50	1 box

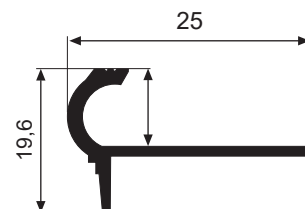



SQUARE STEP ANODIZED ALUMINIUM

matt

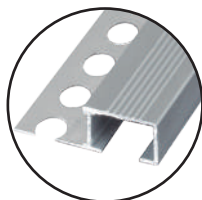
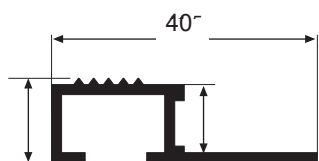

REFERENCE	HIGH	LONG	UNITS BOX	MINIMUM ORDER QUANTITY
DOGA2341M	11	270	50	1 box
DOGA2769M	13	270	50	1 box

CURVED PROFILE ANODIZED ALUMINIUM

matt

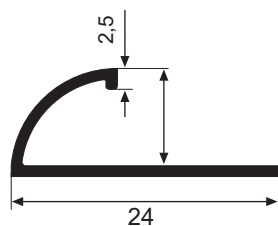

REFERENCE	HIGH	LONG	UNITS BOX	MINIMUM ORDER QUANTITY
DOGA2546M	8	270	50	1 box
DOGA2545M	10	270	50	1 box
DOGA2544M	12	270	50	1 box

shine



REFERENCE	HIGH	LONG	UNITS BOX	MINIMUM ORDER QUANTITY
DOGA2546B	8	270	50	1 box
DOGA2545B	10	270	50	1 box
DOGA2544B	12	270	50	1 box

SQUARE PROFILE ANODIZED ALUMINIUM

matt

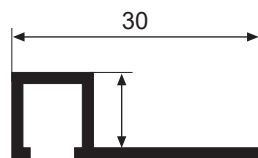

REFERENCE	MEASURES	LONG	UNITS BOX	MINIMUM ORDER QUANTITY
DOGA2681M	10	270	50	1 box
DOGA2680M	12	270	50	1 box

shine



REFERENCE	MEASURES	LONG	UNITS BOX	MINIMUM ORDER QUANTITY
DOGA2681B	10	270	50	1 box
DOGA2680B	12	270	50	1 box



hand tools

GROUT BUCKET BUCKET+GROUT FLOAT

REFERENCE	SR003100
SIZE	15 L.
UNITS BOX	1
MINIMUM ORDER QUANTITY	1 unit



SR003100

NEW GROUT BUCKET PACK CUBE + HYDRO FLOAT + RUBBER FLOAT + ROLLERS

REFERENCE	DGE206643
SIZE	15 L.
UNITS BOX	1
MINIMUM ORDER QUANTITY	1 unit



DGE206643

Sponge floats are tools used to remove finishing products on surfaces that have just been re-laid. The sponge has porosity and softness, which allows the sponge pads to absorb and dispense the right amount of product, allowing uniform application.

There are different types of float, sponge of different densities and degrees of hardness to suit different types of finishing products. It is important to clean the float after use to keep it in good condition.

SPONGE FLOAT **NEW**

REFERENCE	PRODUCT	SIZE	UNITS BOX	MINIMUM ORDER QUANTITY
DGE206360	Sponge float 30mm	280 x 140	10	1 unit
DGE206377	Sponge float with cut 30mm	280 x 140	10	1 unit
DGE206384	Sponge float intermediate	280 x 140	10	1 unit
DGE206391	Cleaning sponge	200 x 125 x 70	12	1 unit
DGE206407	Sponge cleaning bimaterial	170 x 100 x 65	12	1 unit



DGE206360



DGE206377



DGE206384



DGE206391



DGE206407



RUBBER FLOAT KIT

HARD - HALF - SOFT

REFERENCE	SR003898
SIZE	250x95
UNITS BOX	12
MINIMUM ORDER QUANTITY	1 unit



RUBBER FLOAT KIT
SR003898

The rubber to choose depends on the size of the tile:

For large format tiles, a hard rubber (red) is recommended and for smaller formats like cladding or mosaic, a soft rubber (white) is recommended.

Grey rubber is an intermediate.

REFERENCE	PRODUCT	SIZE	UNITS BOX	MINIMUM ORDER QUANTITY
SR003840	Red rubber grout float (hard)	250x95	12	1 unit
SR003841	Grey rubber grout float (half)	250x95	12	1 unit
SR003842	White rubber grout float (soft)	250x95	12	1 unit
SR003890	Red rubber replacement (hard)	250x95	12	1 unit
SR003891	Grey rubber replacement (half)	250x95	12	1 unit
SR003892	White rubber replacement (soft)	250x95	12	1 unit



TOOLS

REFERENCE	PRODUCT	SIZE	UNITS BOX	MINIMUM ORDER QUANTITY
SR30EDGE	Pad suction tile lifter d.115mm	115mm	12	1 unit
SR30BIPL	Double pad suction tile lifter d.115mm	115mm	3	1 unit
OUT0003	Mallet 400gr	400gr	-	1 unit
OUT0004	Mallet 700gr	700gr	-	1 unit
OUT0005	Kneepads	-	-	1 unit
SR2015	Doga spider	37x25x20	12	1 unit
NEW DGE206414	Pliers	-	12	1 unit
NEW DGE206421	Pincer for porcelain	-	12	1 unit
NEW DGE206438	Russian pincer 9"	-	12	1 unit
NEW DGE206445	Rubber spatula	440mm	10	1 unit
NEW DGE206452	Rubber spatula	200mm	10	1 unit



SR30EDGE



SR30BIPL



OUT0003-OUT0004



OUT0005



SR2015



DGE206414



DG206421



DGE206438



DGE206445



DGE206452

CLOSED HANDLE TROWEL WOOD NEW

REFERENCE	PRODUCT	SIZE	UNITS BOX	MINIMUM ORDER QUANTITY
DGE206469	Rectangular stainless-steel trowel	300x140	12	1 unit
DGE206476	Notched stainless-steel trowel 6 mm	280x150	12	1 unit
DGE206483	Notched stainless-steel trowel 8 mm	300X150	12	1 unit
DGE206490	Notched stainless-steel trowel 10mm	300X150	12	1 unit
DGE206506	Sharp trowel	300x140	12	1 unit



DGE206469



DGE206476 - DGE206483 - DGE206490



DGE206506



6 mm



8 mm



10 mm

CLOSED HANDLE TROWEL NEW

REFERENCE	PRODUCT	SIZE	UNITS BOX	MINIMUM ORDER QUANTITY
DGE206513	Rectangular stainless-steel trowel	500x130	4	1 unit
DGE206520	Notched stainless-steel trowel 8 mm	500x130	6	1 unit
DGE206537	Notched stainless-steel trowel 10 mm	500x130	6	1 unit
DGE206544	Grey plastic float	360x190	12	1 unit



DGE206513



DGE206520 - DGE206537



DGE206544



8 mm



10 mm

OPENED HANDLE TROWEL NEW

REFERENCE	PRODUCT	SIZE	UNITS BOX	MINIMUM ORDER QUANTITY
DGE206551	Rectangular stainless-steel trowel	270x130	10	1 unit
DGE206568	Notched stainless-steel trowel 4 mm	270x130	10	1 unit
DGE206575	Notched stainless-steel trowel 6 mm	270x130	10	1 unit
DGE206582	Notched stainless-steel trowel 8 mm	270x130	10	1 unit
DGE206599	Notched stainless-steel trowel 10mm	270x130	10	1 unit
DGE206605	Rounded stainless-steel trowel 15mm	280x120	10	1 unit



DGE206551



DGE206568 - DGE206575
DGE206582 - DGE206599

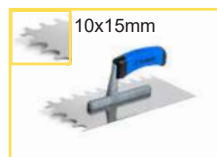

DGE206605



4 mm



6 mm



8 mm



10 mm

BI-COMPONENT HANDLE AND STAINLESS-STEEL PLATE



DGE206551



DGE206568 - DGE206575
DGE206582 - DGE206599

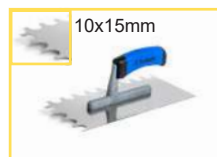

DGE206605



4 mm



6 mm



8 mm



10 mm

Trowels are used to smooth and level surfaces before laying coatings, such as ceramic tiles, tiles, wood, etc. In addition to leveling and smoothing surfaces, Trowels are also used to remove air bubbles and imperfections in putties and mortars before they dry.



MOVABLE TOOL CHEST NEW

REFERENCE	MODEL	SIZES	CONTAINED	MATERIAL	MINIMUM ORDER QUANTITY
DG203666	M	675x472x416mm	2 tray + 2 organizer	PP	1 unit
DG203680	XL	775x472x493mm	2 tray + 2 organizer	PP	1 unit



DG203666



DG203680

- **Organization:** A tool chest allows you to organize your tools in an orderly and easily accessible way.
- **Easy transport:** It's easy to transport from place to place, allowing you to take your tools with you wherever you go.
- **Tool protection:** Protects your tools from damage and dirt, extending their life.
- **Space saving:** It allows you to store a lot of tools in a small space, saving you space in your garage or workshop.
- **Improved safety:** It allows you to keep your tools in a safe place, reducing the risk of accidents.

LEATHER BELTS AND HOLDERS NEW

REFERENCE	PRODUCT	MATERIAL	MINIMUM ORDER QUANTITY
DGE203697	Simple hold belt (5 compartments)	Natural leather	1 unit
DGE203703	Professional hold belt (11 compartments)	Natural leather	1 unit

Adjustable belt



DGE203697



DGE203703

FIX COLLAR NEW

REFERENCE	PRODUCT	SIZES	MATERIAL	CAPACIDAD	MINIMUM ORDER QUANTITY
DGE203710	Fix collar 26	400x350x340mm	Polyethylene. Non-toxic recycled plastic	26 L	1 unit
DGE203727	Fix collar 42	490x430x385mm	Polyethylene. Non-toxic recycled plastic	42 L	1 unit
DGE203734	Fix collar 65	615x560x380mm	Polyethylene. Non-toxic recycled plastic	65 L	1 unit
DGE203741	Construction flexible tub bucket	350x350x330mm	Polyethylene. Non-toxic recycled plastic	26 L	1 unit
DGE203758	Vineyard flexible tub bucket 14	410x330x240mm	Polyethylene. Non-toxic recycled plastic	14 L	1 unit
DGE203765	Vineyard flexible tub bucket 30	470x330x240mm	Polyethylene. Non-toxic recycled plastic	30 L	1 unit



DGE203710



DGE203727



DGE203734



DGE203741



DGE203758



DGE203765



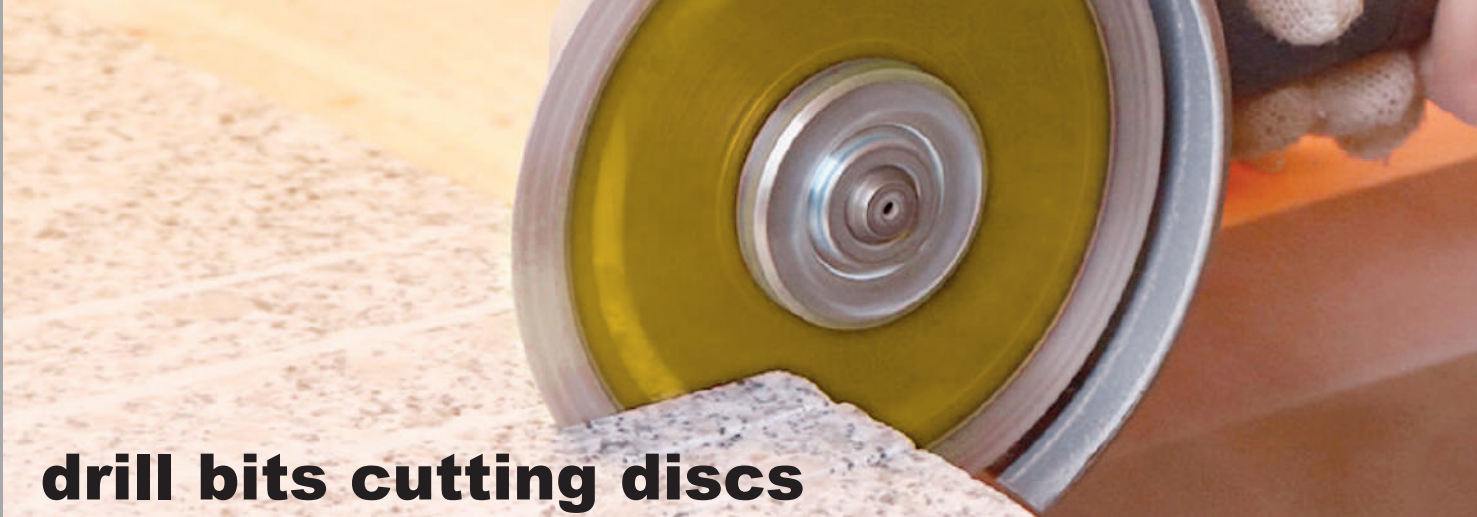

drill bits cutting discs

VACUUM DRILL M-14

REFERENCE	∅
15908 NE00	5
15909 NE00	6
15910 NE00	8
15911 NE00	10
15912 NE00	12
15913 NE00	14
15914 NE00	16
15915 NE00	20
15916 NE00	22
15917 NE00	25
15918 NE00	30
15919 NE00	35
15920 NE00	40
15921 NE00	50
15922 NE00	60
15923 NE00	68
15924 NE00	80
15925 NE00	90
15926 NE00	100
15927 NE00	120



The vacuum bit is used for tile drilling. It has different diameters. Once the tile is drilled, it serves for the passing of pipes, or in bathrooms, to make all the drilling for showers and taps, etc.



CERAMICUT CUTTING DISC

REFERENCE	∅
16407 ST00	250
15505 ST00	300
14890 ST00	350



High speed on porcelain and ultra-compact materials. Also recommended for marble and other hard and non-abrasive materials.



cutting discs



SLIM PORCELAIN ULTRA-COMPACT

REFERENCE	ø
15524 ST00	115
15525 ST00	125
15762 ST00	150
15752 ST00	180



Superfine.
Porcelain and ceramic.

Ceramic cutting discs are specialized cutting discs used to cut ceramics, porcelain and tiles. These discs are made of abrasive materials and have a specific design that allows them to cut these materials efficiently and accurately.

They are used with rotary tools, such as power saws or grinders. They can be used to cut ceramics into straight or curved shapes, according to the disc design.

Some ceramic discs are designed to cut ceramics quickly, while others are designed to cut ceramics accurately and without leaving marks on the surface. There are also ceramic discs with different degrees of abrasion, allowing professionals to choose the right disc for the specific job.

ELECTROCUT MARBLE / FIBERGLASS

REFERENCE	ø
01382 ST00	115
01383 ST00	125
01908 ST00	180
00408 ST00	230



Marbre et fibres.

EPIC ^{20mm} PORCELAIN ULTRA-COMPACT

REFERENCE	ø
15506 ST00	115
15507 ST00	125



Granite, hard materials and porcelain tile 20mm

TURBO SHARK DIAMOND-REINFORCED SIDE

REFERENCE	ø
15775 ST00	115
14717 ST00	125
15776 ST00	150
10666 ST00	180
10667 ST00	230



Granite and other hard materials. Protective side reinforcements to increase resistance to wear.

CUTTING & GRINDING ELECTRO M14

REFERENCE	ø
15555 NE00	125



Porcelain tile cutting and sanding with the same disc. Diamond attached by electroplating.



manual ceramic tile cutter

DOGA CUT PRO

for cutting ceramic and porcelain tiles

REFERENCE	PRODUCT	← cm	↘ cm	⊙ ø mm
SR20090	DOGA CUT PRO 90	90	57x57	22
SR20130F	DOGA CUT PRO 130	130	63x63	22
SR20160F	DOGA CUT PRO 160	160	90x90	22
SR5300	RUBBER TAPESTRY	-	-	-
SR5250	DOGA CUT PRO 90 CASE	-	115x35x25	-
SR52131	DOGA CUT PRO 130 CASE	-	185x35x25	-
SR52132	DOGA CUT PRO 160 CASE	-	195x40x30	-
SR105023	Ø 22 mm wheel with hardened rod	-	-	22
SR115192	Extension kit for measuring guide	-	-	-
SR115200	Spring for side extension	-	-	-
SR115108	± 45° measuring guide	-	-	-
SR115120	Small square	-	-	-
SR115500	Complete handle	-	-	-
SR115600	Bearings 626 6X19X6 mm with plug for handle	-	-	-
SRUC628FULL	Bearings 628 ZZ 8X24X8 mm for handle	-	-	-
SR115589	Spring for wheel	-	-	-
SR115560	Spring cover for wheel	-	-	-
SR645P0M	Clamping knob Ø 20 mm 6x20 for handle head stop	-	-	20
SR606	Spring for metal table	-	-	-
SR105110	Side extension support	-	-	-
SR105115	Spring for side extension support	-	-	-
SR105120	Rubber feet	-	-	-
SR115130	Clamping knob 10x45 mm - ø 40 mm for measuring bar	-	-	40
SR115134	Cup for clamping knob	-	-	-
SR19-31	Clamping knob 6 x 15 mm - Ø 20 mm - small measuring bar	-	-	20
SR12-32	Clamping knob M8 - Ø 50 mm for bar extension	-	-	50
SR105161	Measuring bar tape pushing system	-	-	-
SR105162	Extension measuring bar tape pushing system	-	-	-
SR18-05XTP	Ø 60 mm wheel with mm 10 axis hole (OPTIONAL)	-	-	60

PRODUCT DETAILS:

- Straight cut from 68cm to 160cm, depending on the model
- Diagonal cut from 40x40cm to 90x90 cm
- Cutting thickness 2cm - Wheel ø 12mm with pin art. 148BLI
- Aluminum frame that guarantees its robustness and lightness
- Plans with springs
- Aluminum handle with special offset and anti-scratch protection
- Adjustable angles form -45° to 45 with measuring bar and centimeter scale on the diagonal
- Square with pivot on the cutting line that ensures the real measurement for the straight and diagonal cutting. Equipped with non-slip rubber feet and side supports for large format tiles
- Transport case available upon request

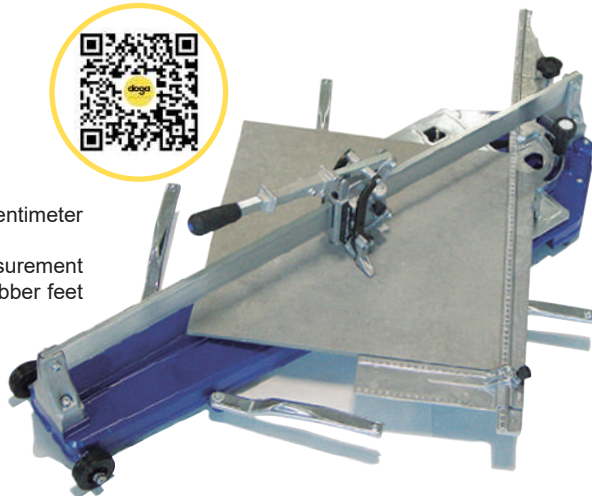



MAXIBELLA TOP 120

Wet saw with 250 mm (10") continuous rim diamond blade

Cortadora refrigerada por agua con disco diamantado ø250 mm

For cutting up to 120 cm (47") porcelain tiles, high thickness as well, marble and granite, with a maximum thickness of 5,5 (2"). The machine is equipped with direct drive; cut switch with thermal cutout; cooling by water pump and flow governor tap; sliding motor unit on four adjustable iron pulleys; tiltable motor unit at 45°; height block; measuring guide for linear and diagonal cuts; 115 x 45 cm (45x18") wide cutting tables.



REFERENCE	PRODUCT	W	cm	cm	ø mm
SR61120	MAXIBELLA TOP 120	1100	120	84x84	25,4
SR61120G	MAXIBELLA TOP 120G	1500	120	84x84	25,4
SR61120P	SIDE EXTENSION	-	-	-	-
SR7297	LEG WITH WHEELS	-	-	-	-
SR103P	DIAMOND DISC 61120	-	-	-	-
SR13360SP	DIAMOND DISC 61120G	-	-	-	-
SR5-0020	230 Hz 50 V ENGINE WITH PLUG	1100	-	-	-
SR5-2020	230 Hz 50 V ENGINE WITH PLUG	1500	-	-	-
SR505-11	SWITCH	-	-	-	-
SR471INT	SWITCH BOX	-	-	-	-
SR734	IMMERSION PUMP	-	-	-	-
SR1025SP	STOP FLANGE	-	-	-	-
SR108128	PULLEY WITH BEARING	-	-	-	-
SR1041	CONICAL CAP 28x37mm	-	-	-	-

DOGA CUT

REFERENCE	PRODUCT	W	cm	cm	ø mm
SR6380KIT	DOGA CUT 3 KIT	-	121-371	45x33x22	13

It includes: Scoring carriage, DOGA GUIDE and plier for splitting.



SR6380

DOGA FLEX 3

REFERENCE	PRODUCT	W	cm	cm	ø mm
SR6350A	DOGA FLEX 3 SS	-	121-371	60x41x26	115

It includes: cutting unit without grinder, disc Ø mm 115 and case.

REFERENCE	PRODUCT	W	cm	cm	ø mm
SR6350	DOGA FLEX 3 CS	-	121-371	60x41x26	115

It includes: cutting unit with Bosch GWS 720W M14 grinder, disc Ø 115 mm and case.

REFERENCE	PRODUCT	W	cm	cm	ø mm
SR6350AXL	DOGA FLEX 3 SG	-	121-371	60x41x26	125

It includes: cutting unit without grinder, disc Ø mm 125 and case.

REFERENCE	PRODUCT	W	cm	cm	ø mm
SR6350XL	DOGA FLEX 3 CG	-	121-371	60x41x26	125

It includes: cutting unit with Bosch 1300W M14 grinder, disc Ø mm 125 and case.



SR6350

DOGA FLEX 3 is a cutting system for large ceramic gres porcelain and marble slabs. It allows linear and 45° cuts and angular profiling. It consists of a sliding carriage for housing an angle grinder with diamond blade to be used on one of guides available. Thanks to four ball bearing pulleys, DOGA FLEX 3 smoothly slides along the guides and it also has a swinging motion for adjusting the depth of the cut. Our system, is the only one with a millimetric adjustment device and two clamps allowing to reach the 45° position of the blade. DOGA FLEX 3 can house most of the angle grinders on the market and is also designed to connect a vacuum cleaner.

DOGA GUIDE 3

REFERENCE	PRODUCT	W	←→ cm	↘ cm	⊙ ø mm
SR17270GC	DOGA GUIDE 270	-	270	202x30x20	-
SR17330GC	DOGA GUIDE 330	-	330	202x30x20	-

The modular aluminium sliding guides, available in two lengths, are equipped with a system to connect the modules (120 cm e 180 cm), with male or female end. The suction cups can be moved to any position on the guide. Thanks to a special rubber profile, the suction cups work on smooth and rough surfaces.



SR17330GC

WORKBENCH

REFERENCE	PRODUCT	W	←→ cm	↘ cm	⊙ ø mm
SR6345	WORKBENCH	-	175x100x85	206x40x22	-
SR6345-1	EXTENSION FOR WORKBENCH	-	175X25X85	-	-

The workbenches have planking and cross pieces in drawn aluminium to guarantee lightness and stability. They come with plastic guards for the drawn parts (top of the workbench) and with a system of adaptation to the ground and height adjustment. Thanks to the available junctions, the workbenches can be easily connected together, to be adapted to the dimensions of the tile sizes to be cut. The workbenches are delivered with foldable legs to facilitate transport.



SR6340

DOGA TROLLEY

REFERENCE	PRODUCT	W	←→ cm	↘ cm	⊙ ø mm
SR6330	DOGA TROLLEY	-	130x50x150	170x38x26	-

Doga Trolley is a lightweight and stable trolley in aluminium for handling large slabs. It has 4 rubber wheels and two slab loading positions; its base is in non-slip wood; equipped with fall protection devices. DogaTrolley is delivered unassembled to facilitate the transport.



SR6330

DOGA MACHO

REFERENCE	PRODUCT	W	←→ cm	↘ cm	⊙ ø mm
SR64000-300	DOGA MACHO 300	-	310x100	170x38x26	-
SR64000-240	DOGA MACHO 240	-	240x100	170x38x26	-
SR64000-150	DOGA MACHO 150	-	150x100	170x38x26	-

This is a system for lifting large slabs up to 300 x 100 cm. Adjustable frame in width, with a pump suction system and cup fault indicator, for lifting slabs with rough and smooth surfaces. To facilitate transport, SiriMacho is delivered unassembled; it consists of two parts measuring 150 cm each which can also be used separately. The maximum vertical load that can be lifted is 40 kg for each suction cup.

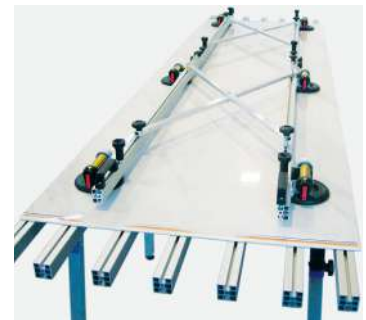

SR6420KIT

DOGA HULK KIT

REFERENCE	PRODUCT	W	←→ cm	↘ cm	⊙ ø mm
SR6420KIT	DOGA HULK KIT	-	200x320	215x40x30	-

Lifting system for slabs up to 320 x 180 cm. Adjustable frame in length from 200 to 320 cm (78"x 126") and in width from 100 to 160 cm (39"x 63"). Equipped with a pump suction system for handling slabs with rough and smooth surfaces and system fall protection.

REFERENCE	PRODUCT	W	←→ cm	↘ cm	⊙ ø mm
SR6420VTKIT	DOGA HULK MAX KIT	-	200x320	215x40x30	-

Lifting system for slabs up to 320 x 180 cm. Adjustable frame in length from 200 to 320 cm (78"x 126") and in width from 100 to 160 cm (39"x 63"). Equipped with a pump suction system with gauge for handling slabs with rough and smooth surfaces and system fall protection.



SR6420KIT



DOGA CLOSE

REFERENCE	PRODUCT	W	cm	cm	ø mm
SR30-3	DOGA CLOSE	-	-	58x20x25	-

Suction cups system to move near large tiles.



SR30-3

DOGA VIBRO

REFERENCE	PRODUCT	W	cm	cm	ø mm
SR30001	DOGA VIBRO	12V	-	42x18x14	-

DOGA VIBRO is a vibrating system for large format tiles and slabs. The vibrating suction cup is Ø 135 mm with 6 power adjustments, locking system with lever, release button and two handles. Supplied with two 12 V batteries, a charger and a suitcase.



SR30001

DOGATABLE

REFERENCE	PRODUCT	W	cm	cm	ø mm
SR6338	DOGATABLE	-	-	115x60x70	-

Professional work-bench for tilers, in marine wood, with sturdy metal frame, foldable and easy to transport.



SR6338

DOGA PUMP

REFERENCE	PRODUCT	W	cm	cm	ø mm
SR30OCTO	DOGA PUMP S	-	-	39x39x15	-

Ø 150 mm (6") vacuum suction cup without case.

REFERENCE	PRODUCT	W	cm	cm	ø mm
SR30OCTOV	DOGA PUMP C	-	-	39x39x15	-

Ø 150 mm (6") vacuum suction cup with case.

REFERENCE	PRODUCT	W	cm	cm	ø mm
SR30OCTO-VT	DOGA PUMP CP	-	-	39x39x15	-

Ø 150 mm (6") vacuum suction cup with gauge - no case.

REFERENCE	PRODUCT	W	cm	cm	ø mm
SR30OCTO-VTV	DOGA PUMP SP	-	-	39x39x15	-

Ø 150 mm (6") vacuum suction cup with gauge and case.

Ø 150 mm (6") vacuum suction cup with red line for vacuum loss. Suitable for smooth and textured surfaces. Maximum vertical load 40 Kg. Maximum horizontal load Kg 70.



SR30OCTOV



SR30OCTO-VT

DOGA HOLDER

REFERENCE	PRODUCT	W	cm	cm	ø mm
SR10035DOP	DOGA HOLDER	-	-	24x17x15	-

Panel holder with jaws to lift ceramic, glass, wood panels, etc. The transparent rubber coating prevents the color of the jaws from staining the workpiece. Possibility of vertical and horizontal lifting.



SR10035DOP

maintenance of porcelain tiles



NEUTRAL CLEANER

REFERENCE **DGNEU-01**
SIZE 1L

Power cleaning. No rinsing needed.
No residues.

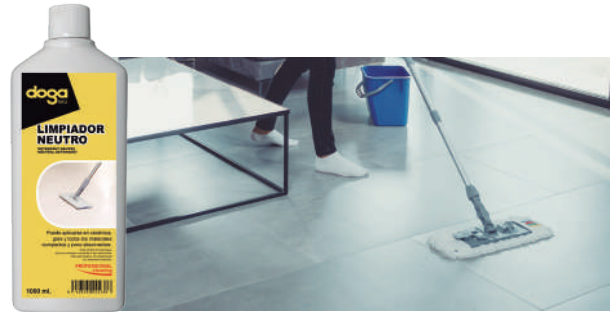

ANTI-SLIP TREATMENT matt

REFERENCE **DGTRA-01**
SIZE 1 L

Anti-slip for wet surfaces.



TILE CLEANER matt

REFERENCE **DGAZU-01**
SIZE 1L

Deep cleaning. Suitable for rough surfaces. Gets rid of surface patina.

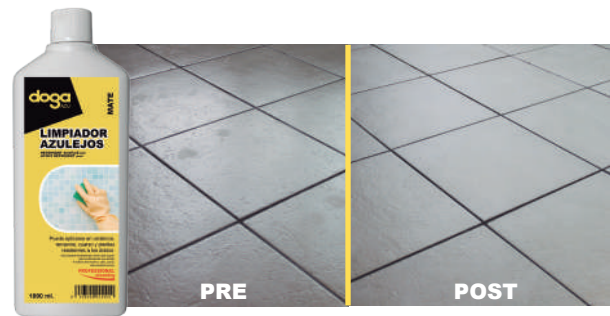

STRONG DEGREASER for polished surfaces

REFERENCE **DGDEP-01**
SIZE 1L

It removes greasy dirt also generated by pedestrian flow.

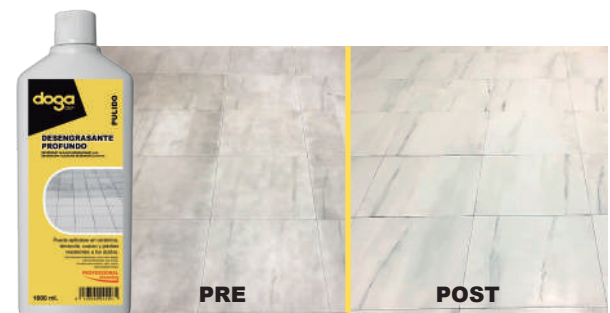



CEMENT CLEANER matt

REFERENCE **DGCEM-01**
SIZE 1L

REFERENCE **DGCEM-05**
SIZE 5L

Residue cleanser from cementitious joints after installation.



REPAIRING CREAM light polish

REFERENCE **DGREPC-25**
SIZE 0.25L

Re-polishing. It reduces the accumulation of dirt, scratches, and defects.

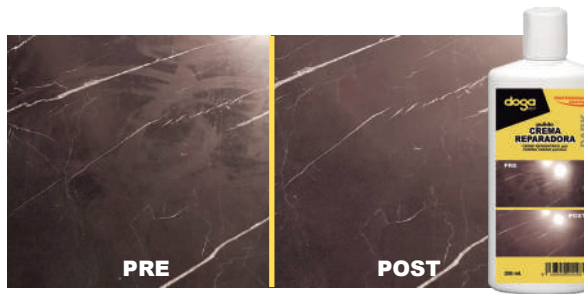

REPAIRING CREAM dark polish

REFERENCIA **DGREPO-25**
TAMAÑO 0.25L

Re-polishing. It reduces the accumulation of dirt, scratches, and defects.



REPAIRING CREAM matt

REFERENCE **DGREP-25**
SIZE 0.25L

It removes back-marks, scratches and defects on natural or textured.

DOGA stone



MAGICAL STONE

REFERENCE **DGMAGIC-50**
SIZE 0.50L

Stain-remover specific for greasy and oil stains



STOP WATER

REFERENCE **DGSTOP-05**
SIZE 5L

Invisible solvent based water-repellent deep penetrating treatment

DOGA drain

NEW

REFERENCE	PRODUCT	SIZE	MINIMUM ORDER QUANTITY
DGE206650	DOGA drain 70	70 mm	1 unit
DGE206667	DOGA drain 80	80 mm	1 unit
DGE206674	DOGA drain 90	90 mm	1 unit
DGE206681	DOGA drain 70 plus	70 mm	1 unit
DGE206698	DOGA drain 80 plus	80 mm	1 unit
DGE206704	DOGA drain 90 plus	90 mm	1 unit

DOGA drain plus is ideal for contouring obstacles such as beams, pipes, cables...

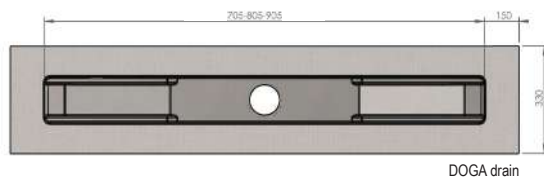

DOGA drain

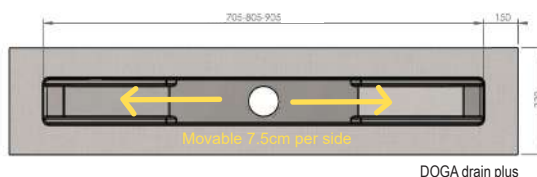

DOGA drain plus

- The outlet of the siphon can be twisted 360° which results in a straight line of the drain pipe towards the stack. This situation gives you a 100% flow rate (34l/m).
- The siphon outlet is 50mm
- The inside siphon "cup" can be removed for access to the waste line (camera inspection or deblocking). The strainer empaches long hair to enter the waste line.
- The drain body has an **integrated 8% slope** (30cm left and right of the siphon) for accelerating and guiding the water towards the siphon. Even when the drain is not installed levelled, the water will run towards the siphon.
- The drain body is deep drawn out of 1 piece which results in seamless corners (round and smooth for better maintenance) and avoids split corrosion in the corners (in case of a welded drain).
- The "grating base" is an important innovation which allows you to create all desired finishing you wished for : glass, stainless steel, wood,... Only 1 rule : the thickness glued on the grating base must be equal or thinner then the surrounding tiles. The ingenious levelling system of the grating base will adjust the levelling up with the surrounding tiles. (The "grating base" is included in the kit and it is recommended to stick it with MS POLYMER)
- Everybody wants "frame less" : no visible silicone and only a slot where the water runs through. This slot can almost eaquel to the tile joints (width of the tile can be different then the width of the grating base). This finish gives a minimalistic look to the shower area.
- Hoover frame : multiple advantages
 1. When the tile installation failed (tiles not straight cut, chips on tile edges,...) you can use the Hoover frame to disguise the imperfections.
 2. You really want a frame finish on the tiles floor
 3. The hoover frame is so discrete and almost invisible
- The **water proofing membrane** is factory bonded on the drain flanges. From here you can continue to water proof your complete shower area.

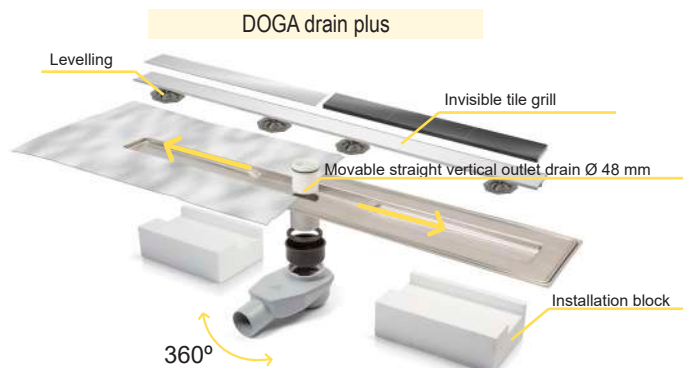
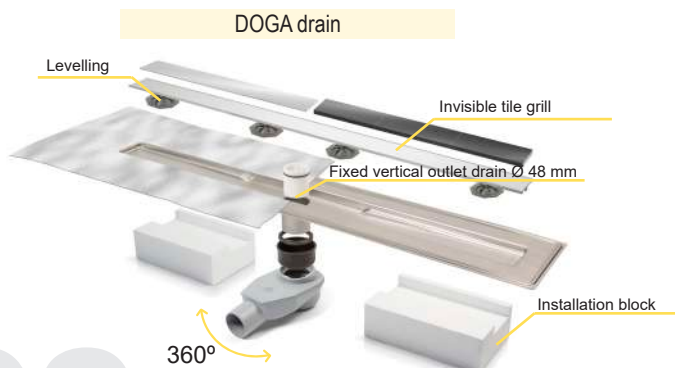



NOVEDADES
NOUVEAUTÉS
NOVELTIES
NEUHEITEN

dogas

LEVELLING SYSTEM

Calle Grecia, 63. Nave 1D
Polígono Industrial Acceso Sur
12006 Castellón de la Plana - España

+34 964 205 294

+34 648 06 60 93

info@dogasystem.com

www.dogasystem.com

